

正面図 3P

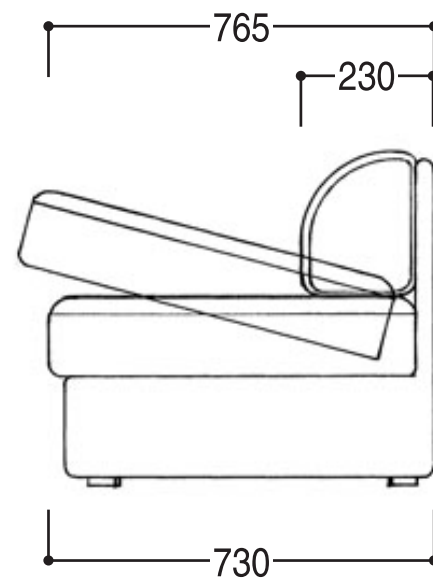

側面図 3P