

正面図 2P

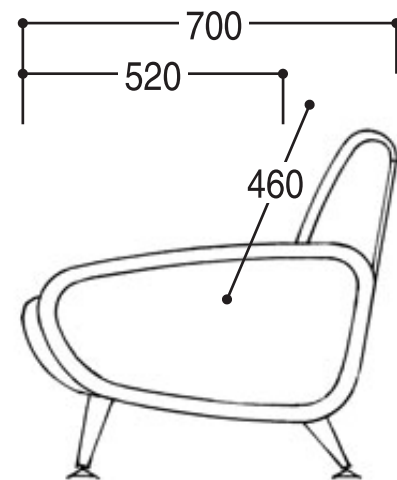

側面図 2P